



CARACTERISTIQUES GENERALES



- Largeur Maximale : 2 bras 5920 mm
- Visserie : INOX A2
- Finition : Laquage RAL 9016 (Blanc)
RAL 7016 (Anthracite)
Autre RAL : **OPTION NON DISPONIBLE**
- Bras : SANGLE 2 paires de bras de 1500 à 3000 mm
- Structure : 80x40x2 mm
- Pose : Fixation au sol (Pieds en surface)
Pieds enterrés ou pieds mobiles en plus-value
- Possibilité : Bras à Led à partir de projection 2000mm
- Possibilité : Sans coffre
- Toile : Toile Acrylique 290 gr/m
Autre toile en plus-value (page 89)
- Lambrequin : 200 mm

Conforme à la norme européenne EN13561 -V 2004

LARGEUR		3600	4800	5920
LYRES		2	2	2
PROJECTION	1500	70Nm	70Nm	70Nm
	2000	70Nm	70Nm	70Nm
	2500		100Nm	100Nm
	3000		100Nm	100Nm

OPTIONS	
SANS COFFRE	
PIEDS MOBILES	
PIEDS ENTERRES	
BRAS A LED LLAZA RADIO*	
BRAS A LED SOMFY RADIO*	
RAL SPECIAL	OPTION NON DISPONIBLE
PV AUTRES TOILES	

* Option BRAS A LED uniquement à partir de Projection = 2.0m

MOTORISATION			
OPTION MANŒUVRE	Couple	70Nm	100Nm
MANUEL			
SOMFY RADIO			
SOMFY RADIO CSI			

CARACTERISTIQUES TECHNIQUES

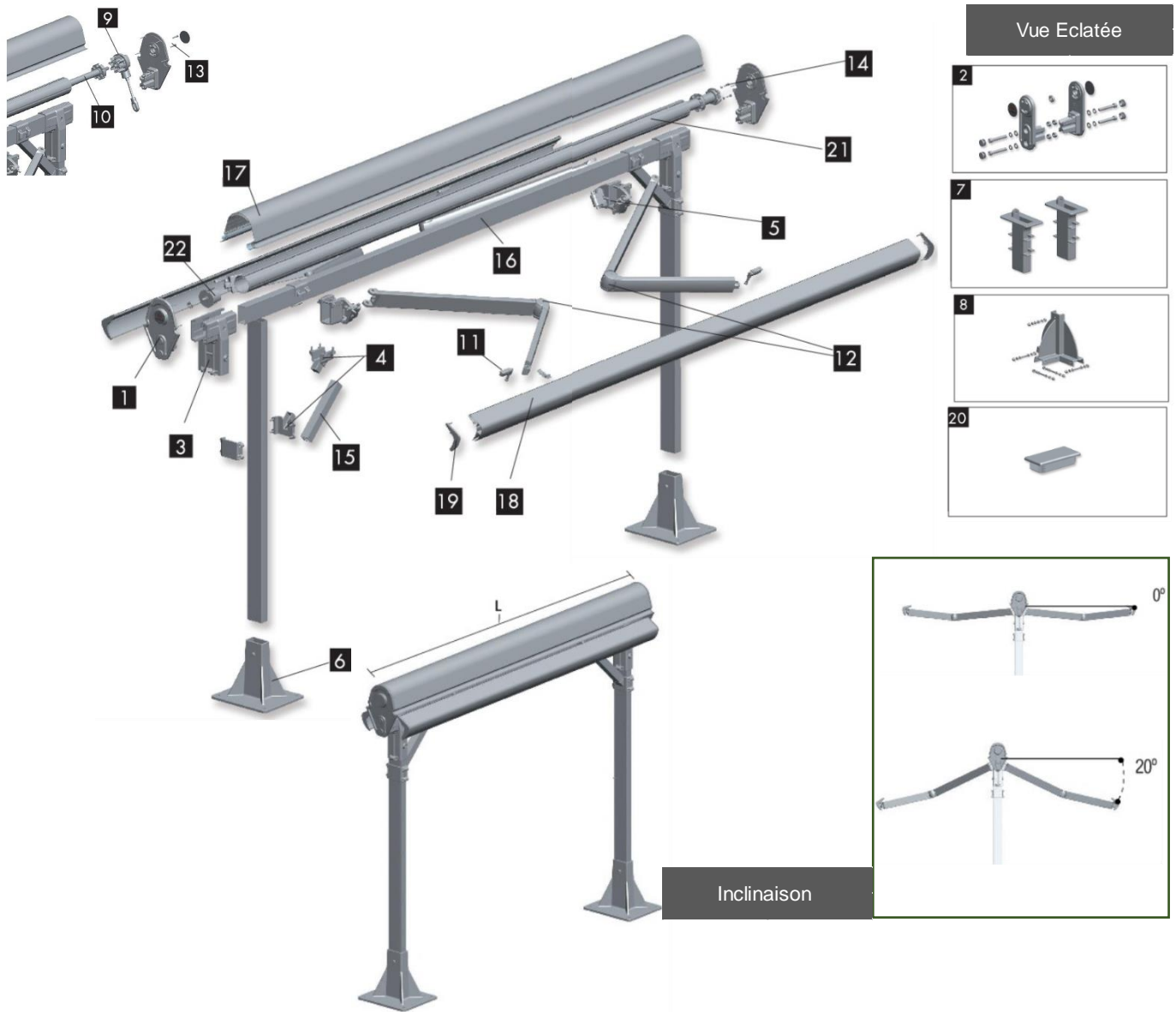

LARGEURS MINIMALES				
Projection	1500	2000	2500	3000
Largeur 2 bras	2650	3150	3650	4150

Pose

Côtes Encombrement



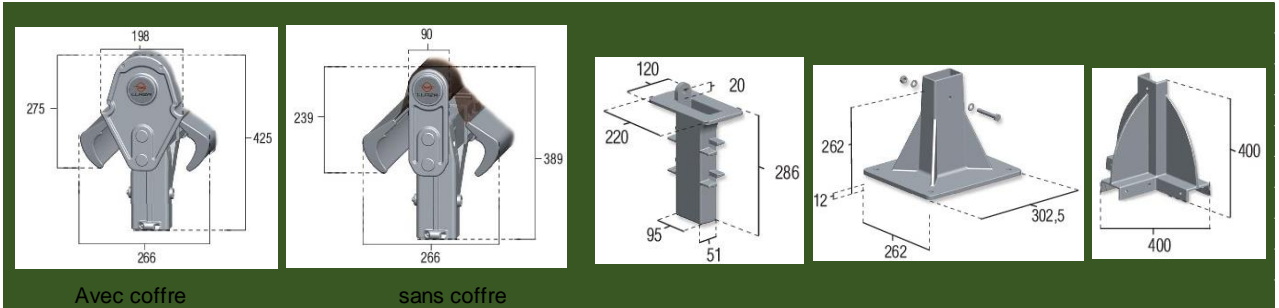



















Support Fixation



Avec coffre

sans coffre

CARACTERISTIQUES TECHNIQUES

1		25100081	KIT SUP T/E COF DBLE PENTE BL	12b		10072001	J BRAS OXYON 400-LED 2.00M
		25100481	KIT SUP T/E DBLE PENTE BL			10072501	J BRAS OXYON 400-LED 2.50M
2		25100181	KIT SUP PIED "T" DBLE PENTE BL	11		10073001	J BRAS OXYON 400-LED 3.00M
		25100281	KIT RENFORT DBLE PENTE BL			19022651	J GRIF B CH DP MS 2 FIX B
3		25100381	KIT SUP BRAS DBLE PENTE BL	13		11022950	KIT VISSERIE TREUIL MR-5
		25100601	PIED SURFACE DBLE PENTE			11024180	KIT VIS MOTEUR DOUBLE PENTE
4		25100501	JEU PIEDS ENTERRES DBLE PENTE	14		38027001	TUBE CARRE 40X40X3 7.0m B
		25100701	PIED AMOVIBLE DOUBLE PENTE			34806001	TE ACIER 80x40x2 B9016 6.00m
5		21080501	TREUIL R. MR-5 L170 Diam 80 BL	15		39716001	PF CF DBLE PENTE (+PVC) 6m BL
		21080400	RESSORT COMPENS. MR-5 Diam 80			36066001	B DE CH C. et DP 6.00m BL
6		10451501	J BRAS ART 350 SANGLE 1.50m	16		14060581	J OBTUR B CH C. et DP BL
		10452001	J BRAS ART 350 SANGLE 2.00m			14404501	BOUCHON 80 x 40 BL
7		10452501	J BRAS ART 350 SANGLE 2.50m	17		31807044	TE RAINURE Diam 80 GALVA 7m
		10453001	J BRAS ART 350 SANGLE 3.00m			12800300	TOUR Diam 80 ALU AXE 12mm
8				18			
9				19			
10				20			
12a				21			
				22			

NOTES: